



621-002 Fliptop Maxi - Roof systems for lengths up to 14m

Fliptop Maxi is our Hydraulic system, which opens from one side and uncovers it for loading. Fliptop Maxi maneuvers with a Hydraulic cylinder in the front or back depending on demand and space. Long roof systems are provided with hydraulic cylinders in both ends.

Ends and the longitudinal tube are made of galvanized steel. All the fulcrums are stored with bearing bushes. The hydraulic cylinder is included in the system, but the control valve is not. Optional several hydraulic components can be ordered, also hydraulic powerpack units with remote control. To avoid strapping the roof when strong wind occurs, we have 2 hydraulic locking solutions as accessories, load holding valves or hydraulic locking bolts with sequence valves. The system demands a maximum of 150 bar hydraulic pressure, variation pending on number of cylinders and length.

System:

621-002-6M Fliptop Maxi

Max length 6,3m, Tubelenght 6m straight, Cylinder in one gable.

This includes: Gable without cylinder, Gable with cylinder, Central tube, Side tube, Screw kit, Tie down rings and Throttle valve.

621-002-8M Fliptop Maxi

Max lenght 8,0m, Tubelenght 8m prebended, Cylinder in one gable.

This includes: Gable without cylinder, Gable with cylinder, Central tube, Side tube, Screw kit, Tie down rings and Throttle valve.

621-002-9M Fliptop Maxi

Max lenght 9,0m, Middle support, Tubelenght 9m straight, Cylinder in one gable.

This includes: Gable without cylinder, Gable with cylinder, Central tube, Side tube, Screw kit, Tie down rings, Middle support with side tube connected and Throttle valve.

621-002-10M Fliptop Maxi

Max lenght 10,0m, Middle support, Tubelenght 10m straight, Cylinders in both ends.

This includes: 2 Gable with cylinder, Central tube, Side tube, Screw kit, Tie down rings, Middle support with side tube connected, Dividing valve and Throttle valve

621-002-12M Fliptop Maxi

Max lenght 12,0m, Middle support, Tubelenght 6m straight, Cylinders in both ends.

This includes: 2 Gable with cylinder, Central tube, Side tube, Screw kit, Tie down rings, Middle support with all tubes connected, Dividing valve and Throttle valve.

621-002-14M Fliptop Maxi

Max lenght 14,0m, Middle support, Tubelenght 7m straight, Cylinders in both ends.

This includes: 2 Gable with cylinder, Central tube, Side tube, Screw kit, Tie down rings, Middle support with all tubes connected, Dividing valve and Throttle valve.

Tarpaulin:

188-000-1 Fliptop Maxi Tarpaulin single layer. L=5m

188-000-11 Addition for lengths over 5m

188-000-5 Fliptop Maxi Tarpaulin double layer. L=5m

188-000-55 Addition for lengths over 5m

188-000-6 Fliptop Maxi Tarpaulin isolated. L=5m

188-000-66 Addition for lengths over 5m

This includes: Tarpaulin and mounting details.

Accessories:

188-569-2 Straight bracket for side tube.

188-570-2 Angle bracket for side tube.

233-112 QuickLock.

233-580 Stop sleeve, QuickLock.

621-171 Protective plate to gable, galvanized 3mm.

621-186 Protective plate to gable, galvanized 5mm.

621-006 Hydraulic locking bolts with sequence valves, fitted gable.

621-011 Extra cylinder in system with only one cylinder.

This applies to 621-002-(6M/8M/9M)

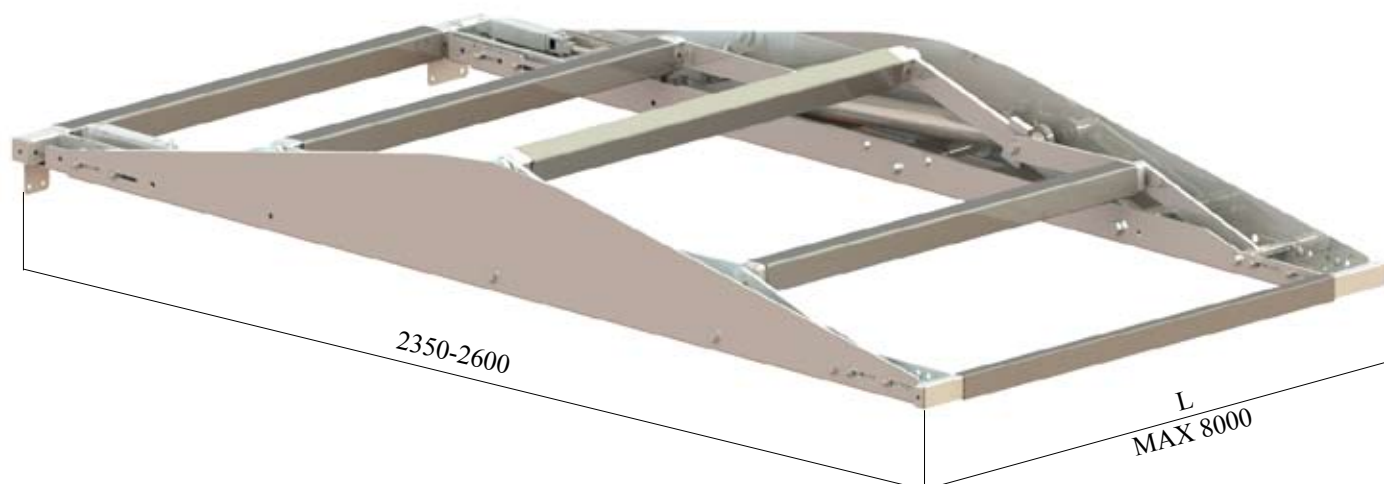

Article list - art.nr. 621-002-8M

- 1 st **621-007** Gable with hydraulic cylinder
Galvanized
62 kg



- 1 st **621-008** Gable
Galvanized
41 kg

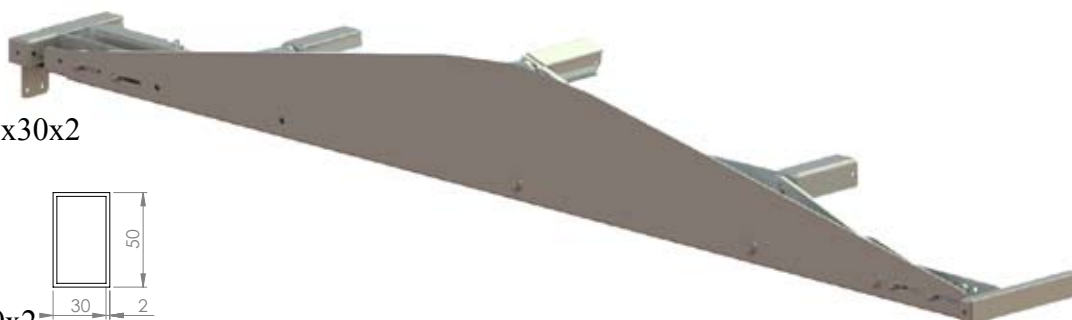

- 1 st **12329 FZB** Steel tube 50x30x2
Galvanized L=6-8m
2,4 kg/m

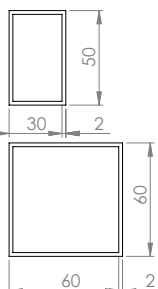

- 4 st **621-201** Steel tube 60x60x2
Galvanized L=6-8m
3,7 kg/m

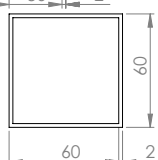

- 1 st **621-301** Screw Kit
- | | |
|---------------------|---------------------|
| 2 st M8 Locknut | 4 st M8x20 |
| 2 st M8 Washer | 2 st M8x75 |
| 14 st M10 Locknut | 2 st M10x50 |
| 28 st M10 Washer | 12 st M10x75 |
| 2 st Tie down rings | 1 st Throttle valve |
| 4 st Rope clamps | |

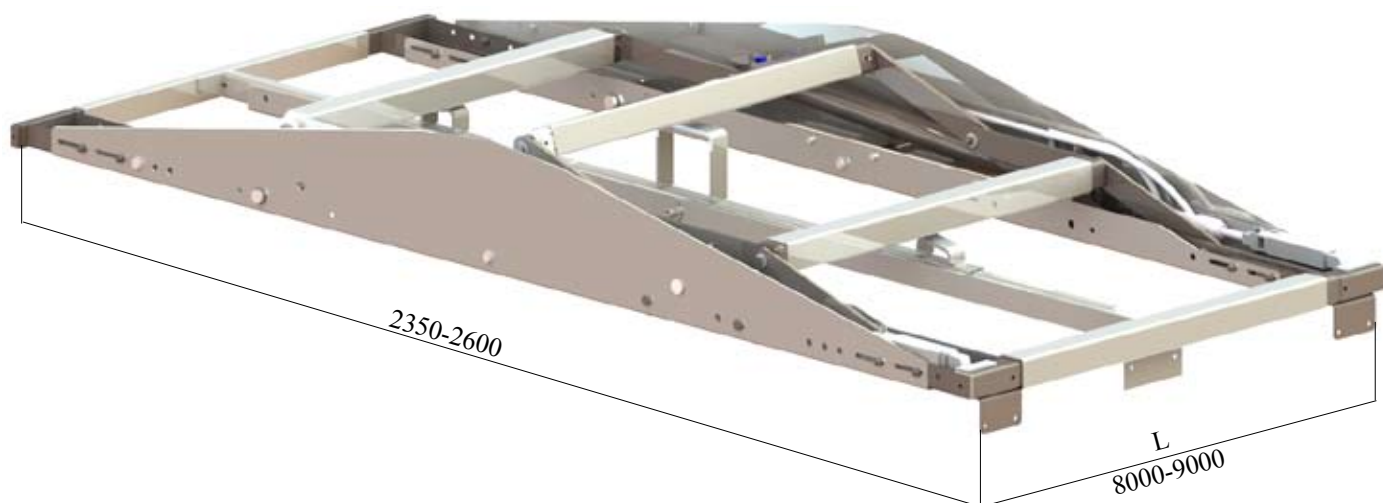

Article list - art.nr. 621-002-9M

- 1 st **621-007** Gable with hydraulic cylinder
Galvanized
62 kg



- 1 st **621-008** Gable
Galvanized
41 kg

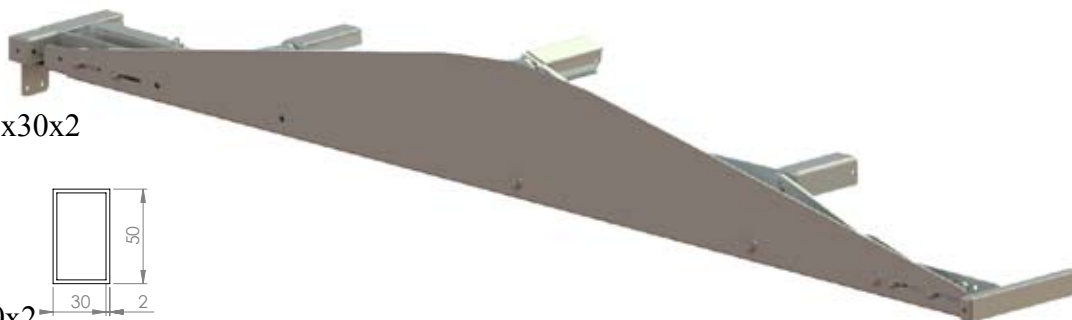

- 1 st **12329 FZB** Steel tube 50x30x2
Galvanized L=8-9m
2,4 kg/m

- 4 st **621-201** Steel tube 60x60x2
Galvanized L=8-9m
3,7 kg/m

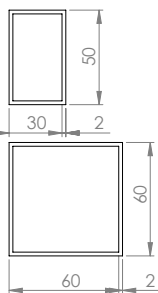

- 1 st **621-003-1** Arch support
with outer tube connected
Galvanized
21 kg



- 1 st **621-314** Screw Kit

- | | |
|---------------------|---------------------|
| 2 st M8 Locknut | 4 st M8x20 |
| 2 st M8 Washer | 2 st M8x75 |
| 18 st M10 Locknut | 4 st M10x50 |
| 36 st M10 Washer | 12 st M10x75 |
| 2 st Tie down rings | 2 st M10x80 |
| 4 st Rope clamps | 1 st Throttle valve |

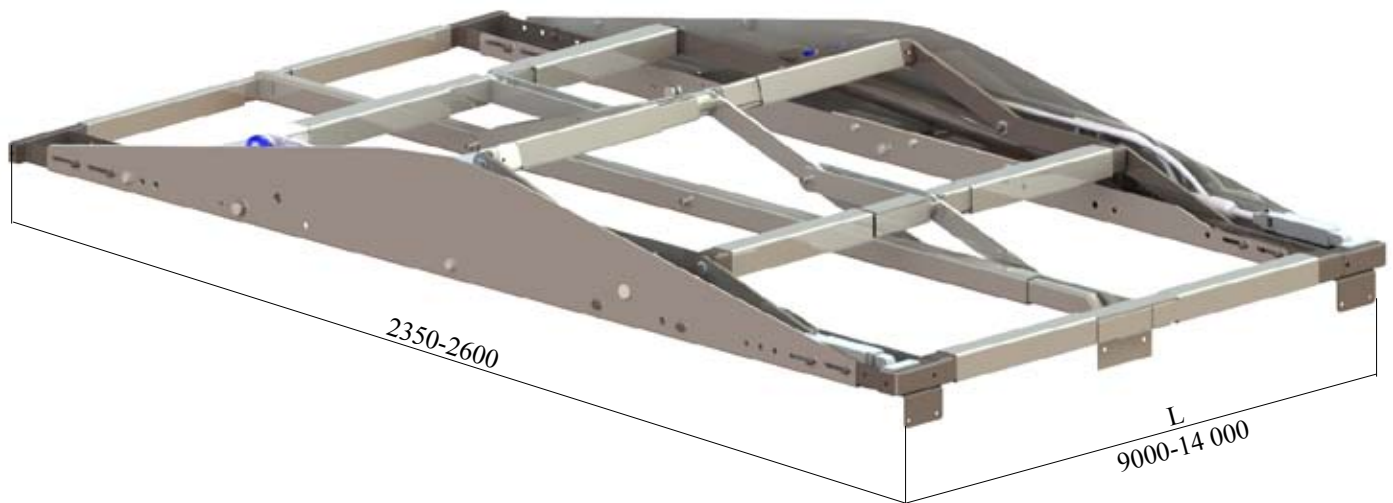

Article list - art.nr. 621-002-14M

- 2 st **621-007** Gable with hydraulic cylinder
Galvanized
62 kg

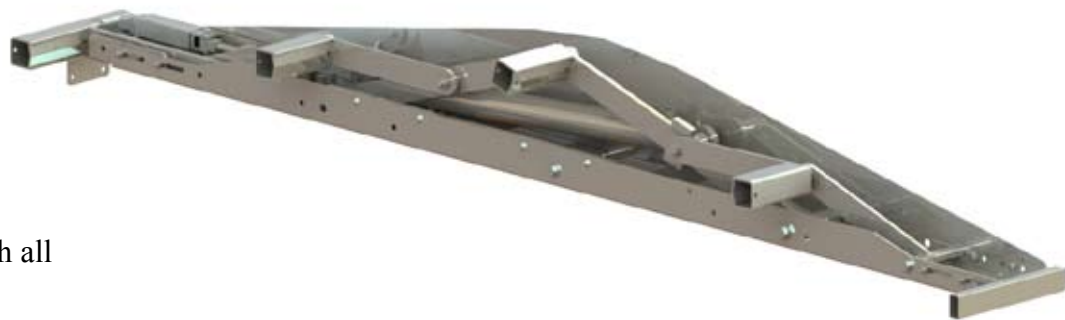

- 1 st **621-004** Arch support with all tubes connected
Galvanized
40 kg



- 1 st **12329 FZB** Steel tube 50x30x2
Galvanized L=9-14m
2,4 kg/m

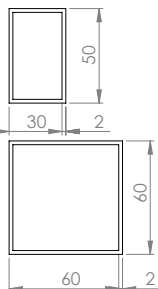

- 4 st **621-201** Steel tube 60x60x2
Galvanized L=9-14m
3,7 kg/m

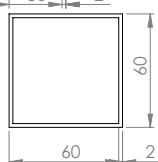

- 1 st **621-315** Screw kit
- | | |
|---------------------|---------------------|
| 2 st M8 Locknut | 4 st M8x20 |
| 2 st M8 Washer | 2 st M8x75 |
| 28 st M10 Locknut | 4 st M10x50 |
| 56 st M10 Washer | 24 st M10x75 |
| 2 st Tie down rings | 2 st Throttle valve |
| 4 st Rope clamps | |

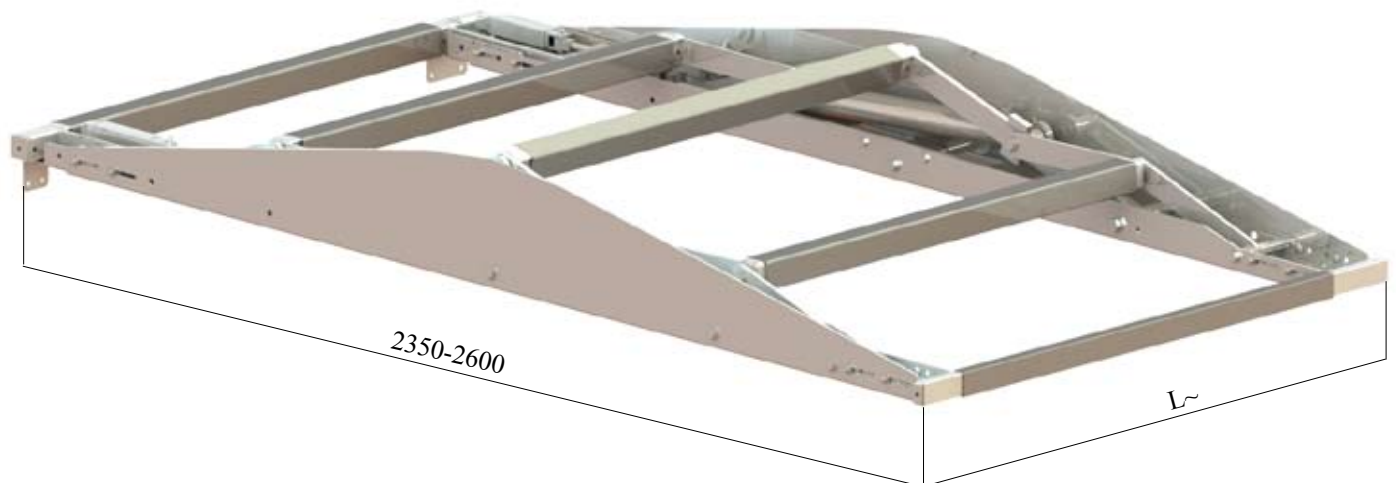

Article list - art.nr. 621-002 Accessories

621-171 Protective plate
Galvanized
14,5 kg

621-186 Protective plate
Galvanized
8,6 kg

188-569-2 Bracket
Galvanized
0,4 kg

188-570-2 Bracket
Galvanized
0,1 kg

233-112 QuickLock
Stainless steel
1 kg

233-580 Stop
Stainless steel
0,1 kg

621-006 Hydraulic locking
bolt with sequence valve
4,2 kg

